

**Product:** VZ HOLDER 03

**Product code:** 303

Holder for vertical protection

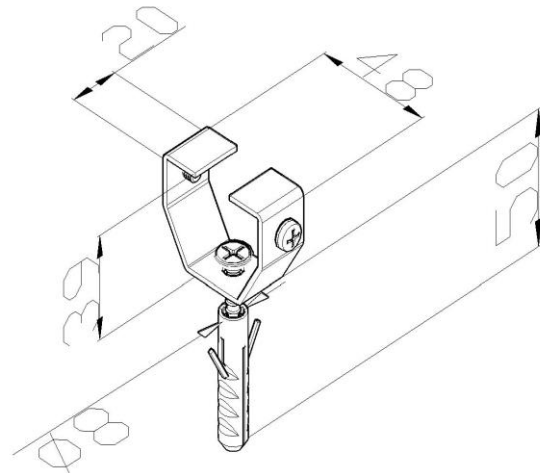

<b>Standard:</b>	EN 62561-4:2017: Lightning protection system components (LPSC) - Part 4: Requirements for conductor fasteners
<b>Dimensions:</b>	Length: 48 mm
	Width: 20 mm
	Height: 39 mm
	Screw length: 50 mm
	Wall plug diameter: $\phi 8$ mm
<b>Material:</b>	Weight: 0,05 kg
	Stainless steel