

Product: PKP-OE 60/400

Product code: 88701176

Add-on tee

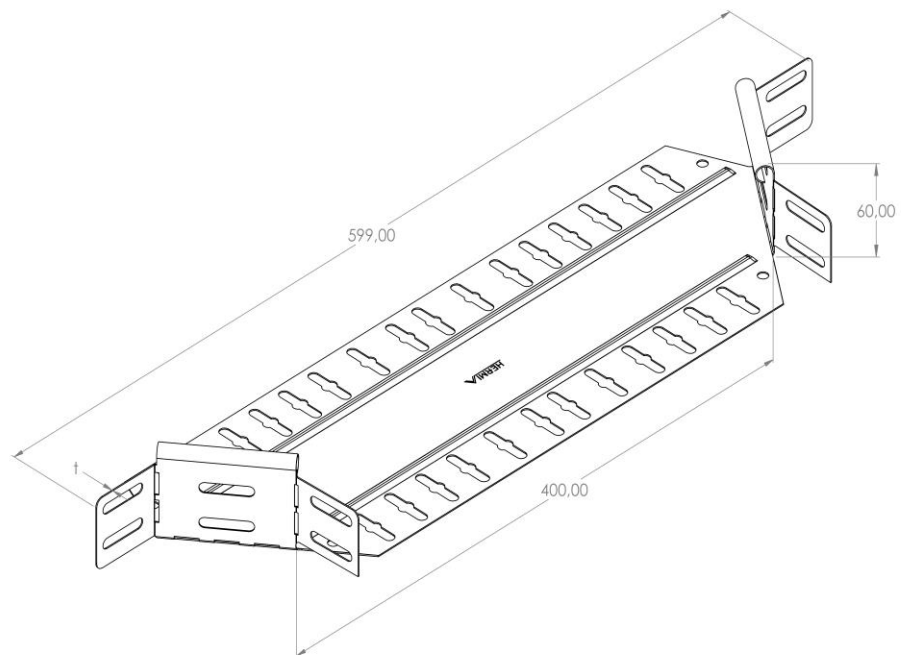

Standard:	EN 61537:2007 Cable management - Cable tray systems and cable ladder systems
Dimensions:	Length: mm
	Width: 400/599 mm
	Height: 60 mm
	Metal thickness: 0,80 mm
Weight:	0,5 kg
Material:	Galvanised steel
Contribution to fire:	Non-flame propagating system
Electrical characteristics:	Electrically conductive system
Electrical continuity:	Yes
Corrosion resistance:	Class 3
Temperature:	Min: -20°C; Max: +105°C