

Product: NKP-SNL 60

Product code: 88704100

Wall bracket

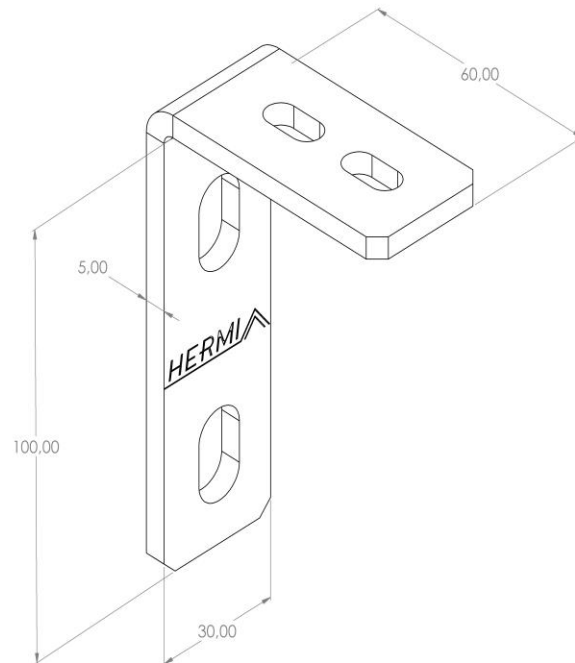

Standard:	EN 61537:2007 Cable management - Cable tray systems and cable ladder systems
Dimensions:	Length: 60 mm
	Width: 30 mm
	Height: 100 mm
	Metal thickness: 5 mm
Maximum load:	1,9 kN
Weight:	0,17 kg
Material:	Galvanised steel
Contribution to fire:	Non-flame propagating system
Electrical characteristics:	Electrically conductive system
Electrical continuity:	Yes
Corrosion resistance:	Class 3
Temperature:	Min: -20°C; Max: +105°C