

Product: NKP-SNT 610

Product code: 88704146

Wall bracket

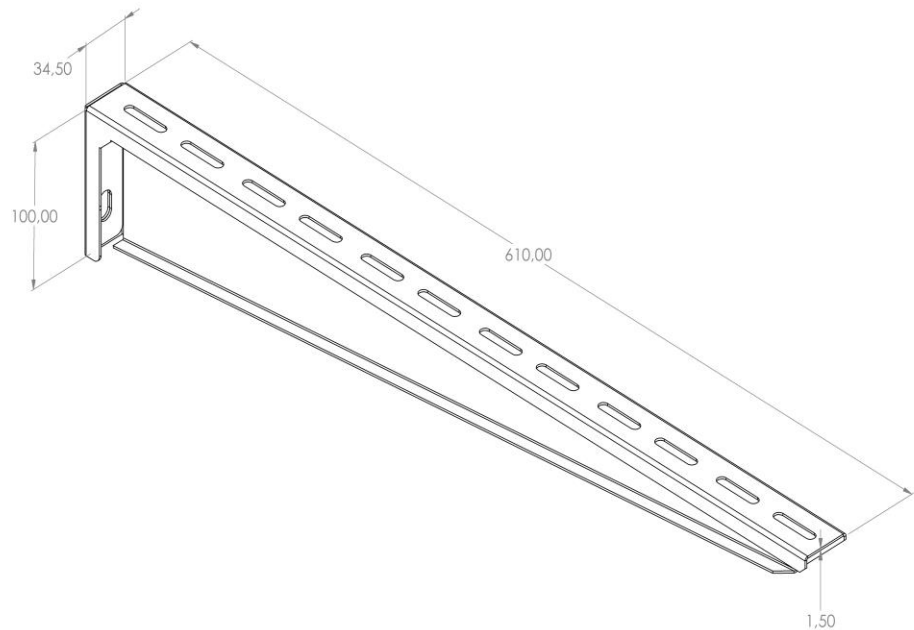

Standard:	EN 61537:2007 Cable management - Cable tray systems and cable ladder systems
Dimensions:	Length: 610 mm
	Width: 34,5 mm
	Height: 90 mm
	Metal thickness: 1,5 mm
Maximum load:	1,3 kN
Weight:	0,91 kg
Material:	Galvanised steel
Contribution to fire:	Non-flame propagating system
Electrical characteristics:	Electrically conductive system
Electrical continuity:	Yes
Corrosion resistance:	Class 3
Temperature:	Min: -20°C; Max: +105°C