

Product: NKP-C 41/21

Product code: 88707115

Profile

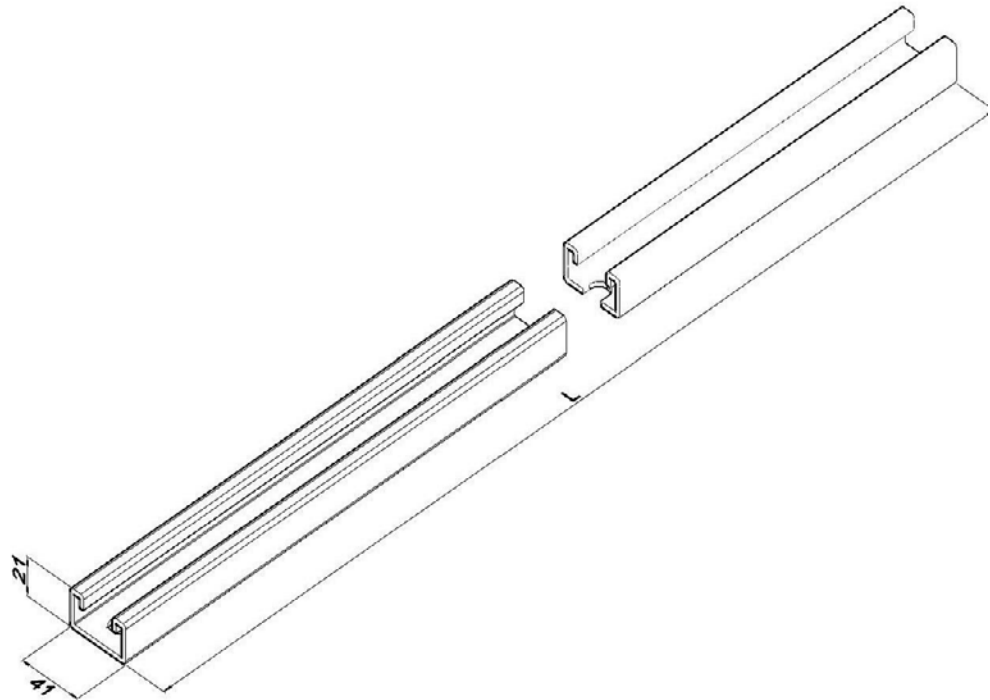

Standard:	EN 61537:2007 Cable management - Cable tray systems and cable ladder systems
Dimensions:	Length: 3000 mm
	Width: 41 mm
	Height: 21 mm
	Metal thickness: 1,5 mm
Maximum load:	
Weight:	3,8 kg
Material:	Galvanised steel
Contribution to fire:	Non-flame propagating system
Electrical characteristics:	Electrically conductive system
Electrical continuity:	Yes
Corrosion resistance:	Class 3
Temperature:	Min: -20°C; Max: +105°C