

Product: KON05-1

Product code: 90211

Contact clamp for lightning conductor

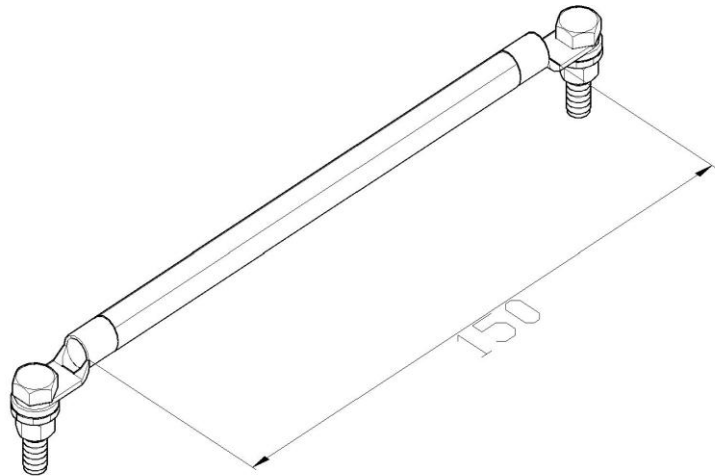

Standard:	EN 62561-1:2017: Lightning Protection System Components (LPSC) - Part 1: Requirements for connection components
Dimensions:	Length: 150 mm
	Width: Hole 8 mm
	Height:
	Weight: 0,09 kg
	Conductor dimensions 1:
	Conductor dimensions 2:
Material:	tinned copper
Withstand lightning current class:	