

Product: LOP-PB2/M16

Product code: 301492

Attachment kit suitable for placing lightning rods on flat roofs

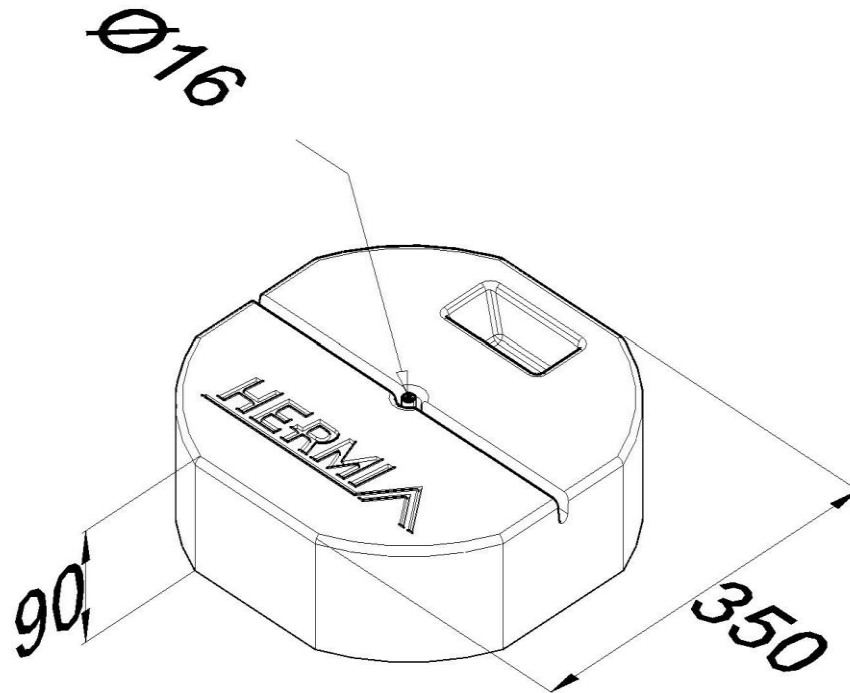

Standard:	EN IEC 62561-2:2018: Lightning Protection System Components (LPSC) - Part 2: Requirements for conductors and earth electrodes
Dimensions:	Length: 350 mm
	Width:
	Height: 90 mm
	Diameter: ϕ 16 mm
	Weight: 18 kg
Material:	Concrete