

**Product:** PKP-NK 60/100

**Product code:** 88701111

Internal elbow 90°

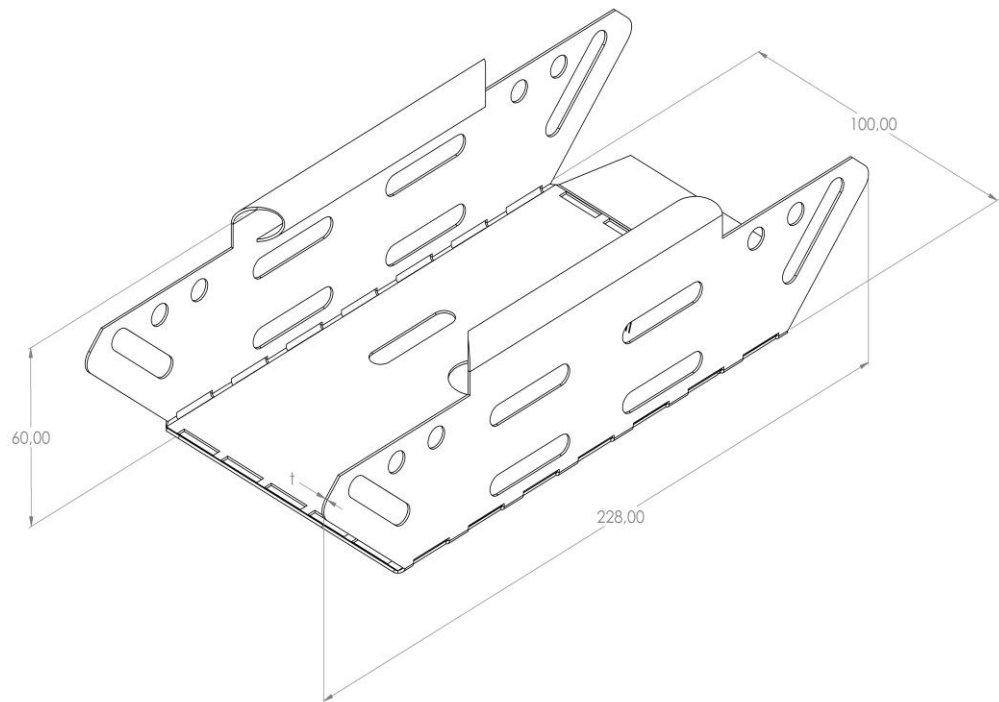

<b>Standard:</b>	EN 61537:2007 Cable management - Cable tray systems and cable ladder systems
<b>Dimensions:</b>	Length: 100 mm
	Width: 228 mm
	Height: 60 mm
	Metal thickness: 0,80 mm
<b>Weight:</b>	0,23 kg
<b>Material:</b>	Galvanised steel
<b>Contribution to fire:</b>	Non-flame propagating system
<b>Electrical characteristics:</b>	Electrically conductive system
<b>Electrical continuity:</b>	Yes
<b>Corrosion resistance:</b>	Class 3
<b>Temperature:</b>	Min: -20°C; Max: +105°C